

Pedestals for Molded Grating

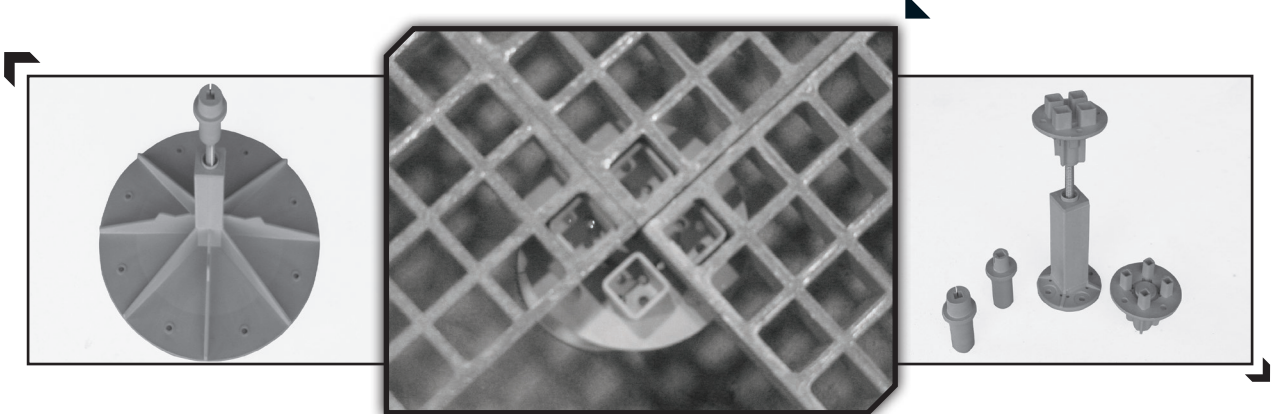

High Performance Composite Solutions



Molded Grating Pedestals

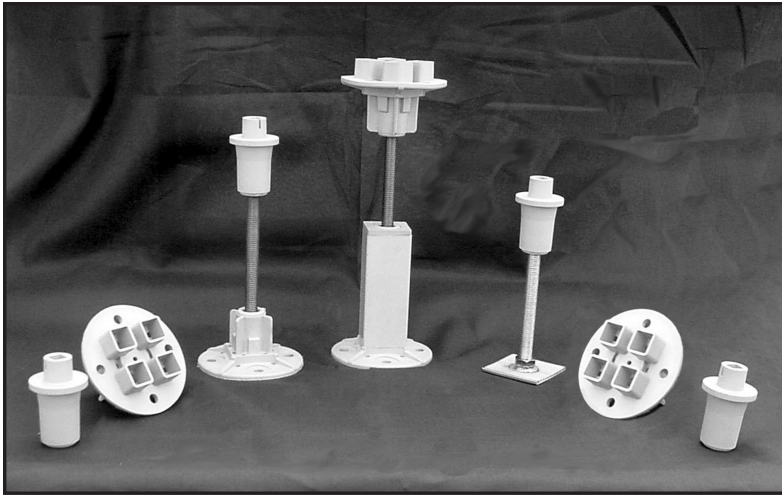

For nearly 50 years, Fibergrate customers have been taking advantage of the benefits offered by using Fibergrate's grating pedestals to create elevated flooring. Over time, these pedestal offerings have been improved to offer more adjustability for added grating configurations. Fibergrate's state-of-the-art grating pedestals are offered for Fibergrate® square mesh molded gratings in depths of 1", 1-1/2" and 2". This increased offering provides more flexibility in designing your raised flooring application as economically as possible.

Made with the same quality as all Fibergrate products, these specially designed pedestals are manufactured to provide safe support for elevated flooring. Pedestal supported floors are versatile; they can be modified or moved from place to place as necessary, and pedestals are generally more cost effective than beam support systems. Pedestals take full advantage of the bidirectional strength of square mesh molded gratings, eliminating additional costs of structural shapes, drafting, fabrication and installation.

Adjustable pedestals are available in heights from 3-1/4" to 42" (*up to 72" with additional bracing - contact Fibergrate for more information*). Pedestals are available with single heads for 1-1/2" and 2" square mesh grating and quad heads (for panel abutments and corners) to fit all Fibergrate® brand square mesh molded gratings. The ease of adjustability of the pedestals will save installation time on sloped floors. Single heads can be adjusted from atop the grating with a 1/2" drive socket, dramatically decreasing time spent during the leveling process, especially in floors under 18" high or where obstructions are present. Reference pages 7 - 11 for layouts and page 4 for pedestal configurations and part numbers needed.

These injection-molded, fire-retardant, glass-filled grating pedestals are low maintenance, as are all of Fibergrate's products, and provide excellent corrosion resistance. They are designed to be resistant to most industrial wet floor applications such as plating, clean rooms and wash down areas.

Fibergrate Markets

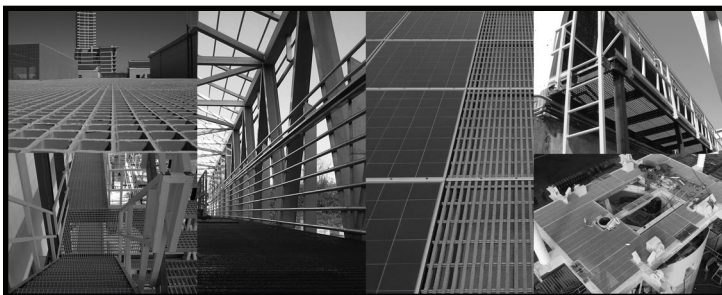

- Architectural
- Bridge & Highway
- Chemical
- Commercial
- Food & Beverage
- Manufacturing
- Metals & Mining
- Microelectronics
- Oil & Gas
- Pharmaceutical
- Power
- Pulp & Paper
- Recreation
- Telecommunications
- Transportation
- Water & Wastewater

Pedestal Features



Corrosion Resistant: Made with thermoplastic polyester and pultruded vinyl ester parts, pedestals are designed to be resistant to most industrial wet floor applications for long service life.



Fire Retardant: Flame spread rating of 25 or less, as tested in accordance with ASTM E-84, and meets the self-extinguishing requirements of ASTM D-635.



Non Conductive: FRP pedestal support heads provide electrical insulation from the supporting surface making the system safer for workers.



Long Service Life: Fiberglass products provide outstanding durability and corrosion resistance in demanding applications, therefore providing improved product life over traditional materials.



Adjustable: Can be installed to create a level walking surface even on sloped floors. Adjustable pedestals are available in a selection of designs ranging in height from 3-1/4" to 42".



Low Install Cost: Economical way of providing a raised flooring structural support system. Compared to standard braced support systems, Fibergrate's pedestals maintain the lowest installed cost for elevated flooring.



Light Weight: Modular concept and lighter weight component materials promote faster installation with fewer laborers and no lifting equipment.



Easy Installation: The elements can be easily repositioned as required for new layouts and designs. The system does not require floor penetrations.

Single Head Pedestal Retaining Clips

(Used to install single head pedestals in the center of 4' & 5' wide panels.)

For 1" deep grating order part number #577220, for 1-1/2" grating #577230, or for 2" grating #577240

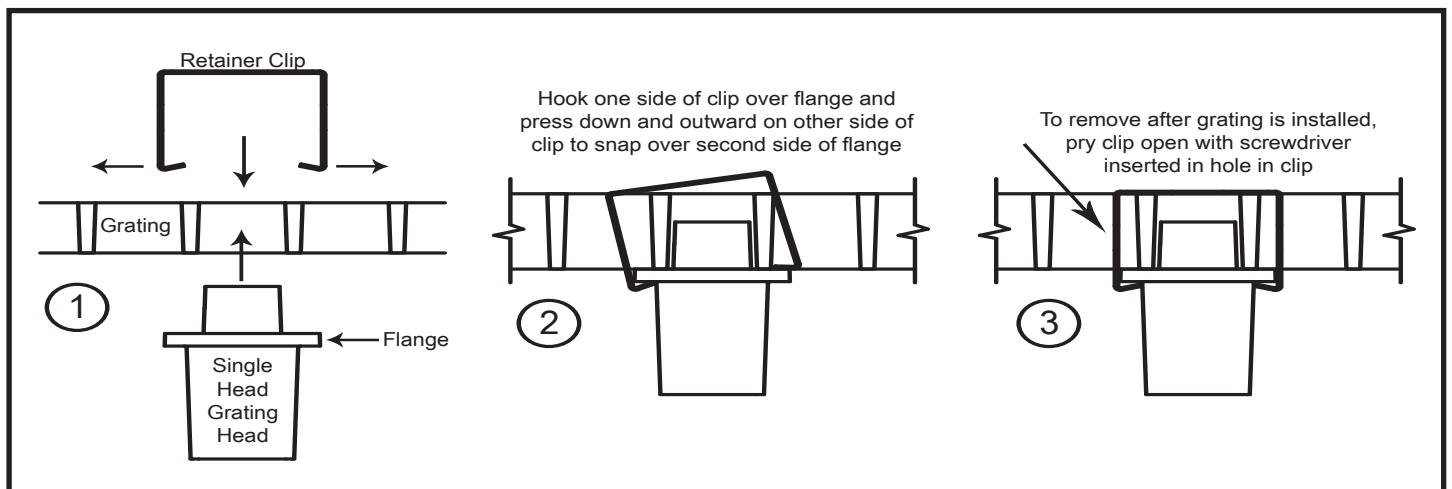

Pedestal Selection Procedure

1. Use the layouts given on pages 7 through 11 and select the required grating and pedestal layout based on the grating depth, the most efficient panel utilization, and the load and deflection requirements for your installation. Refer to the project specifications for loading and deflection requirements. If designing for pedestrian loads, use the layout for 50 psf (pounds per square foot)/300 lb point loads. If your requirements differ from the ones listed, contact Fibergrate for assistance.
2. Following this layout, sketch a plan view of the installation that shows the grating panels and the pedestals, indicating which pedestals have single heads and which have quad heads. The 1-1/2" Single Head works for 1-1/2" square mesh gratings and the 2" Single Head works for 2" square mesh gratings.
3. Determine the maximum and minimum 'A' dimension of the grating installation. The 'A' dimension is the distance from the bottom of the grating to the floor. There is not an adjustable pedestal for 'A' dimensions of less than 3-1/4". If your A dimension requirement is less than 3-1/4", alternate solutions such as fixed height legs or rubber feet may be possible. Contact Fibergrate for assistance in developing a support system for your application.

4. Once you have completed your layout and know the lengths of your pedestals and which heads you require, use the chart below to select part numbers for your order. It may be necessary to use several different pedestal heights for a given installation. For example, if the 'A' dimension of your installation ranges from 14 to 20 inches, two heights of pedestals are required. Note that all of the adjustment ranges overlap by 1" to 3" so that there is some flexibility built in for errors in height measurements or pedestal counts.

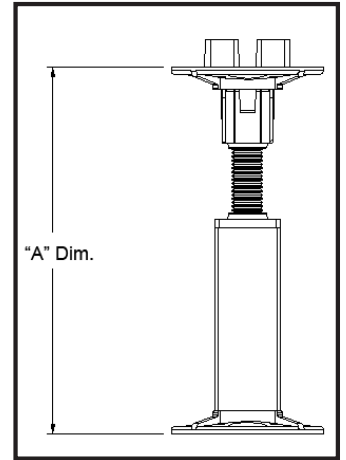

Please Note for Installation:
Fibergrate grating pedestal system is designed to provide structural support for walking surface; however, lateral support should be provided through attachment to adjacent equipment or containing the grating within perimeter walls of grating layout area.

Pedestal Configuration	'A' Range		Total Adjustment	Head		
	Min.	Max.		Single Head		Quad Head Fibergrate®
				1-1/2"	2"	
Mini Base	3-1/4"	4-3/4"	1-1/2"	561103	562103	563103
	4"	5-1/2"	1-1/2"	561104	562104	563104
	4-3/4"	6-1/4"	1-1/2"	561105	562105	563105
Standard 5" Base	5-1/4"	7-3/4"	2-3/4"	561205	562205	563205
	6-3/4"	9-1/2"	2-3/4"	561207	562207	563207
	8-3/4"	11-1/2"	2-3/4"	261209	562209	563209
Extended 5" Base	9-1/2"	14"	4-1/2"	561310	562310	563310
	12"	18"	6"	561312	562312	563312
	15"	21"	6"	561315	562315	563315
	18"	24"	6"	561318	562318	563318
	21"	27"	6"	561321	562321	563321
	24"	30"	6"	561324	562324	563324
	27"	33"	6"	561327	562327	563327
	30"	36"	6"	561330	562330	563330
	33"	39"	6"	561333	562333	563333
36"	42"	6"	561336	562336	563336	

Note: Available to 72" - contact Fibergrate for more information on extended lengths and bracing

Pedestal Drawings

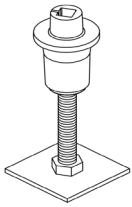

1-1/2" Single Head
PN 5611xx

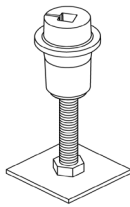

2" Single Head
PN 5621xx

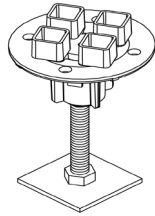

Fibergrate® Quad Head
PN 5631xx

Mini Pedestal Series (A= 3-1/4" - 6-1/4")
with 316 Stainless Steel Base
(xx Denotes Leg Height Refer to Chart of page 4)

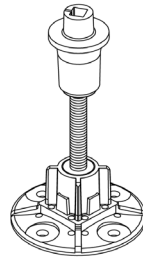

1-1/2" Single Head
PN 5612xx

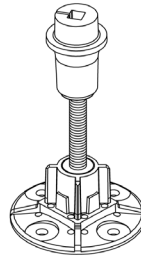

2" Single Head
PN 5622xx

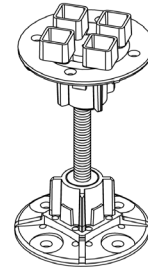

Fibergrate® Quad Head
PN 5632xx

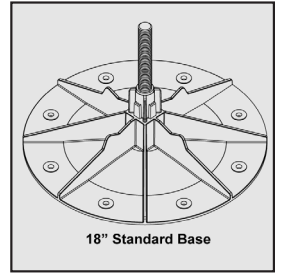

18" Standard Base

Standard Pedestal Series (A= 5" - 11-1/2")

**Available In All 3
Head Styles**
Call Fibergrate for more
information.

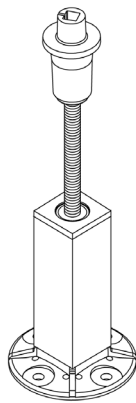

1-1/2" Single Head
PN 5613xx

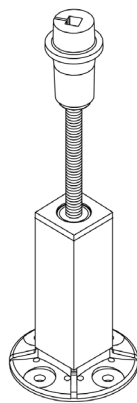

2" Single Head
PN 5623xx

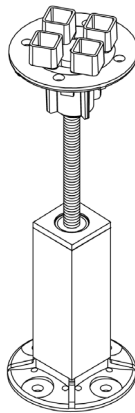

Fibergrate® Quad Head
PN 5633xx

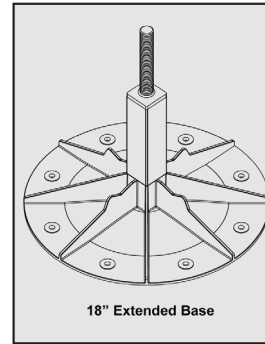

18" Extended Base

Extended Pedestal Series (A= 9-1/2" - 42")

Contact Fibergrate for more information on extended lengths and bracing.

**Available In All 3
Head Styles**
Call Fibergrate for more
information.

Grating Pedestals Used as Columns

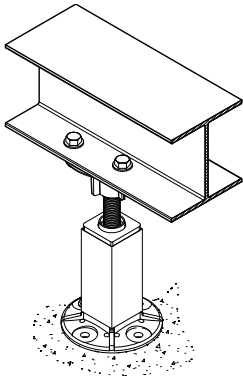

Isometric

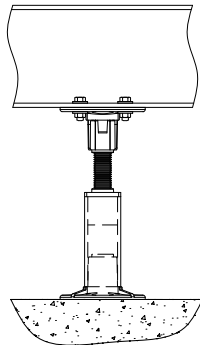

Side View

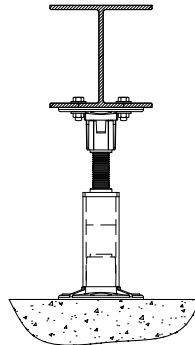

Front View

Fibergrate's pedestal system can be used to support a structural shape beam system.

This structural system can be then used to support rectangular mesh molded or pultruded gratings. (Both require continuous support.)

Consult Fibergrate for details.

Pedestal Drawings

Pedestals

(Shown with Single Head)

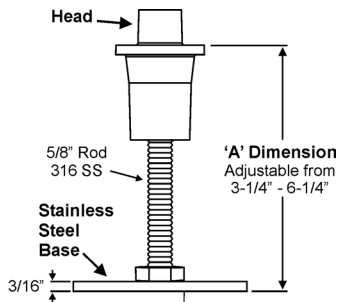

Mini Pedestal Elevation

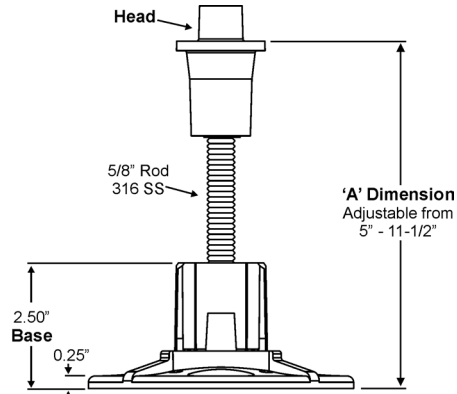

Standard Pedestal Elevation

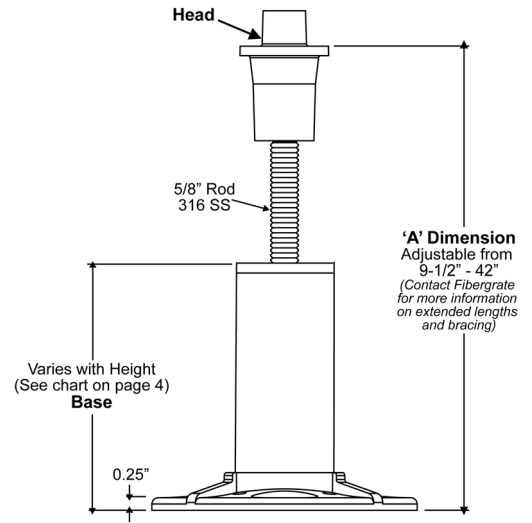

Extended Pedestal Elevation

Top View

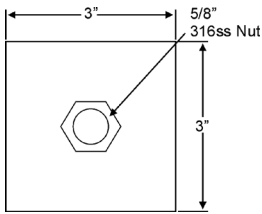

Mini Pedestal Base Plan

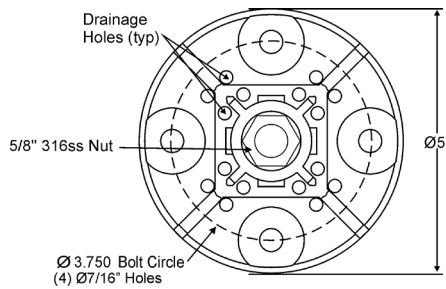

Standard Pedestal Base Plan

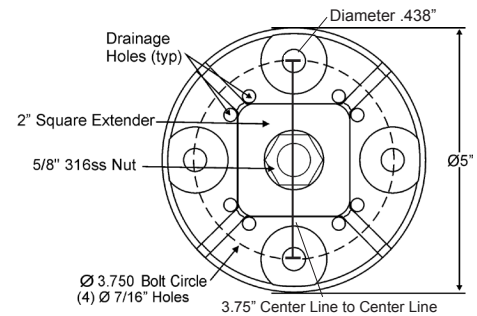

Extended Pedestal Base Plan

Heads

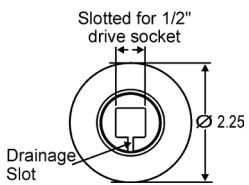

Plan

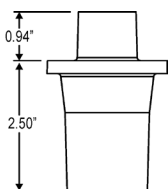

Elevation

1-1/2" Square Mesh Single Head

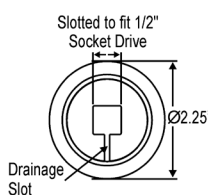

Plan

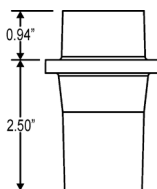

Elevation

2" Square Mesh Single Head

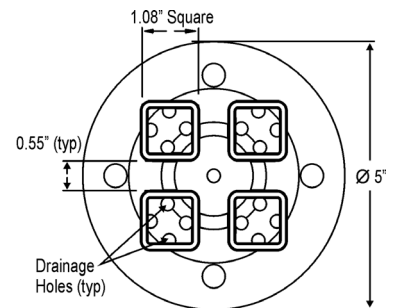

Plan

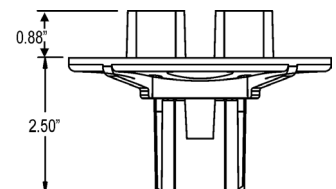

Elevation

Fibergrate® Quad Head

Pedestal Layouts

1" deep x 1-1/2" square mesh
 Pedestrian Traffic Support
 50 psf or 300-lb concentrated load
 deflection $\leq 0.375"$

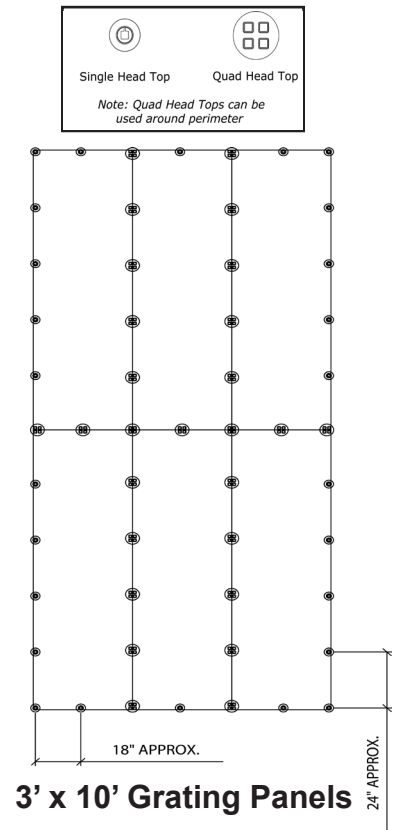
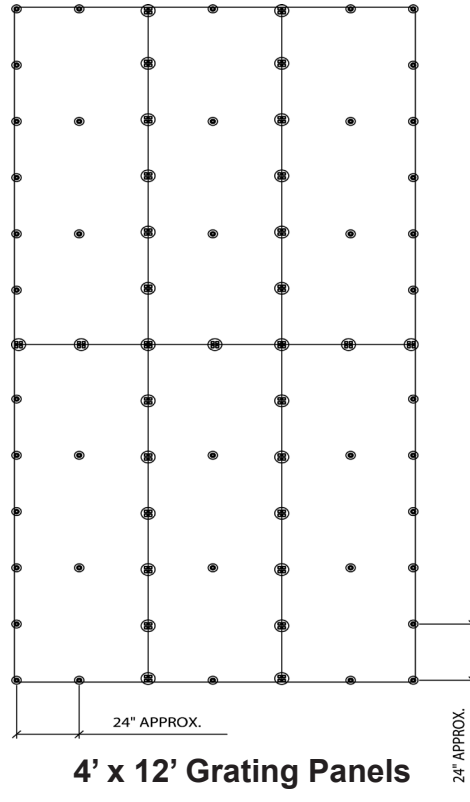
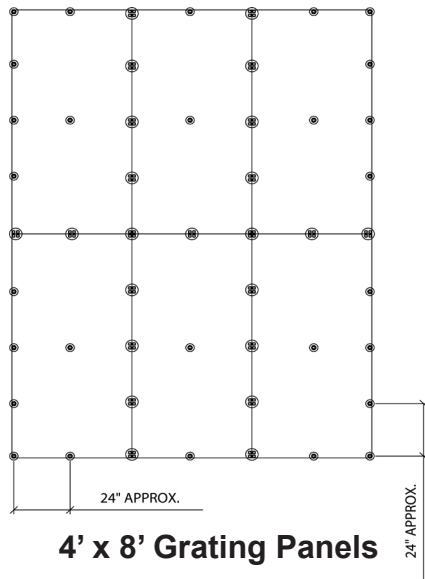

1" deep x 1-1/2" square mesh
 100 psf
 deflection $\leq 0.25"$

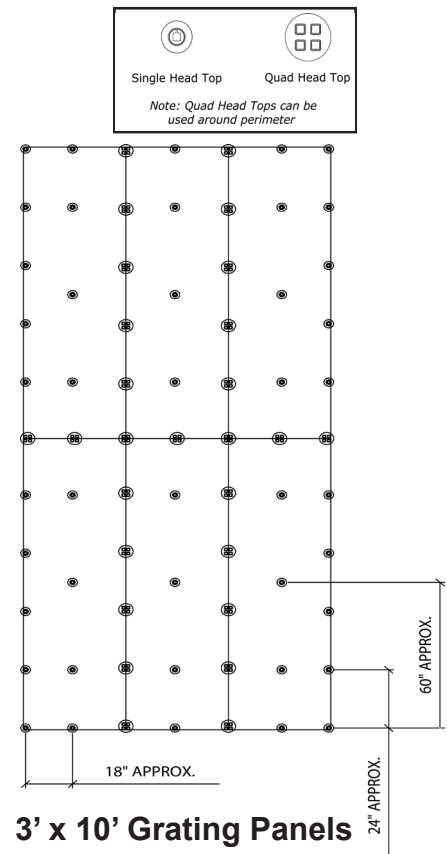
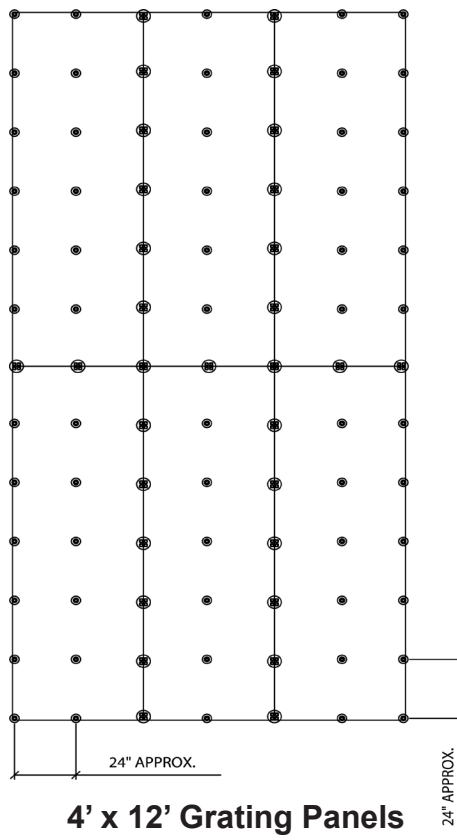
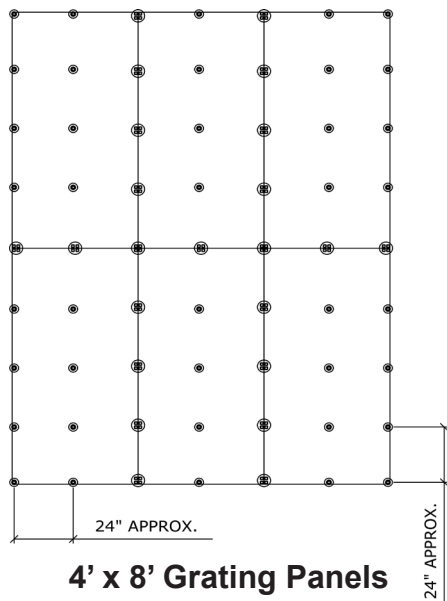

Pedestal Layouts

1-1/2" deep x 1-1/2" square mesh
Pedestrian Traffic Support
 50 psf or 300-lb concentrated load
 deflection $\leq 0.375"$

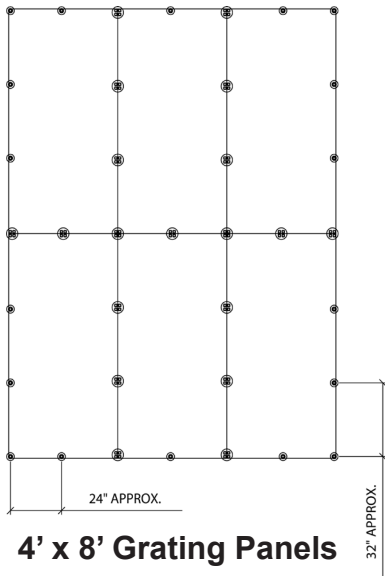

4' x 8' Grating Panels

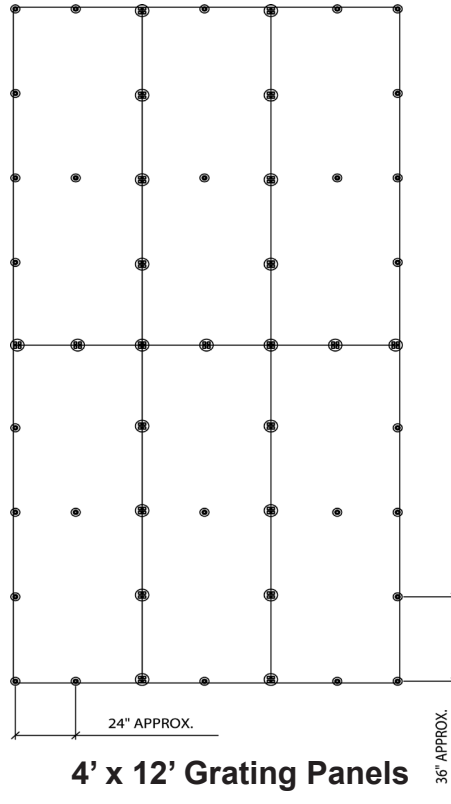

4' x 12' Grating Panels

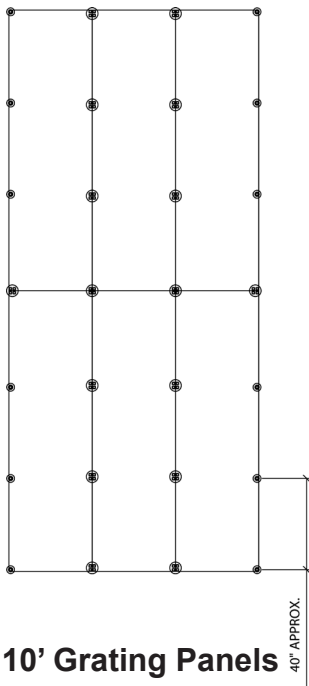
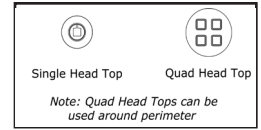

3' x 10' Grating Panels

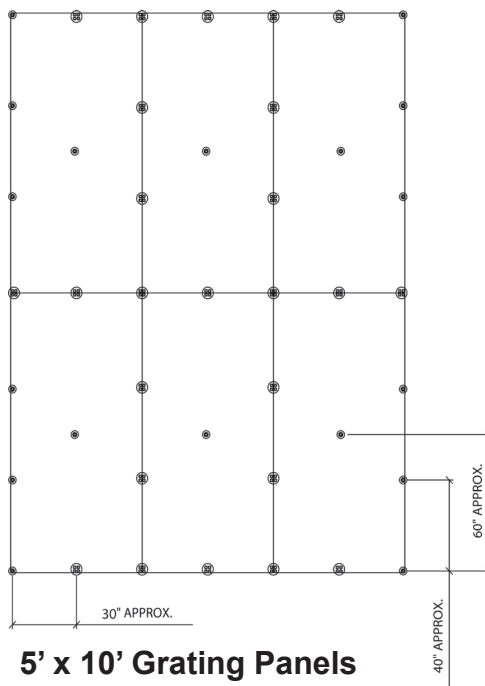

5' x 10' Grating Panels

Pedestal Layouts

1-1/2" deep x 1-1/2" square mesh
 100 psf
 deflection $\leq 0.25"$

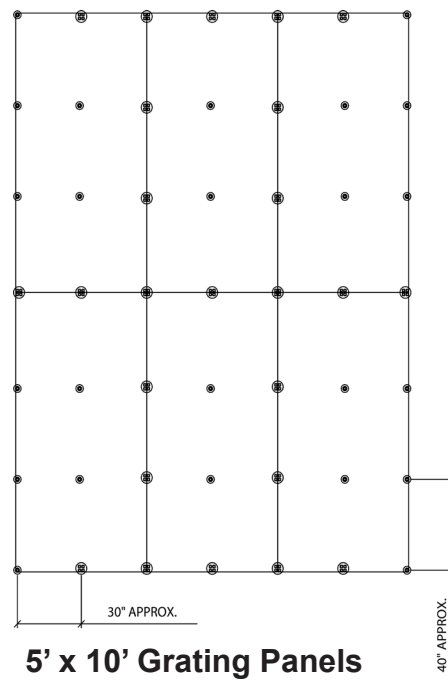
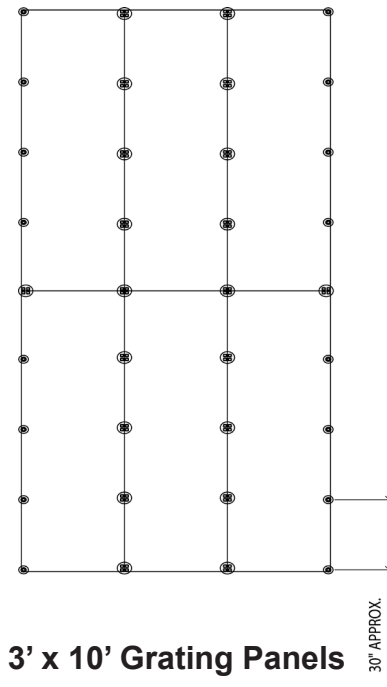
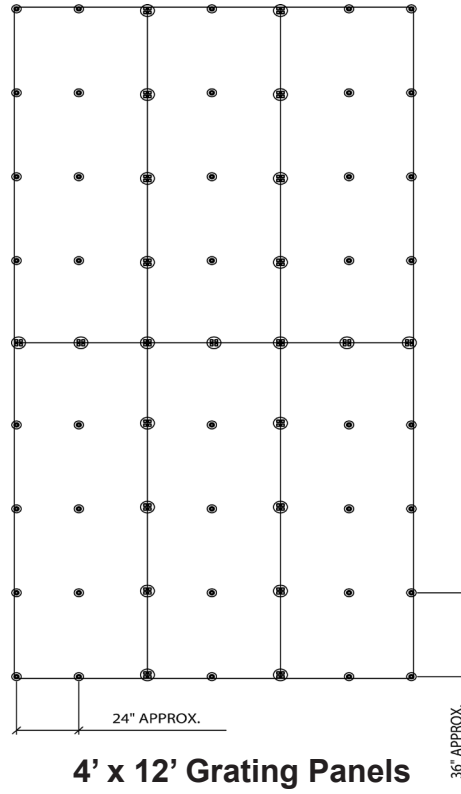
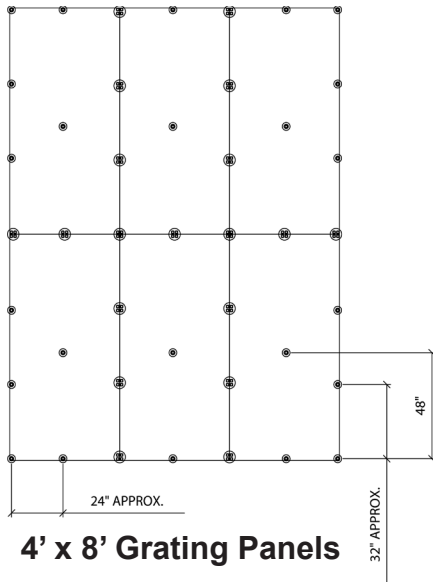
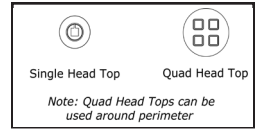

Pedestal Layouts

1-1/2" deep x 1-1/2" square mesh
 200 psf
 deflection $\leq 0.25"$

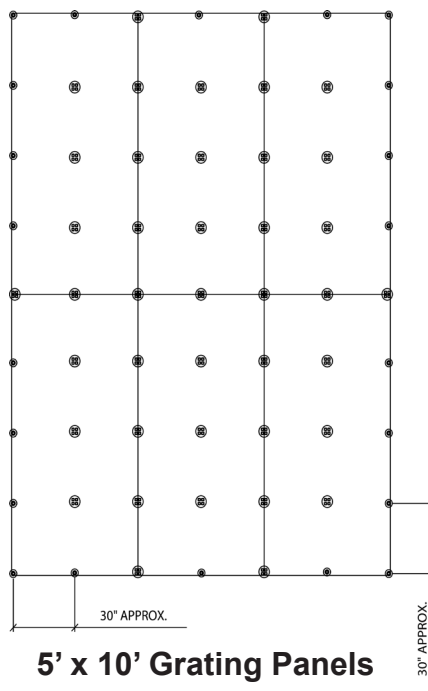
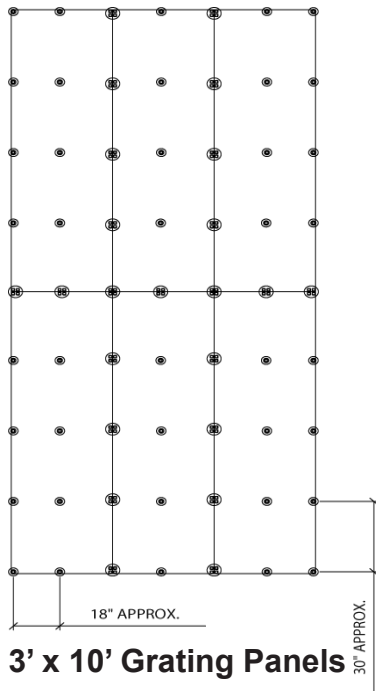
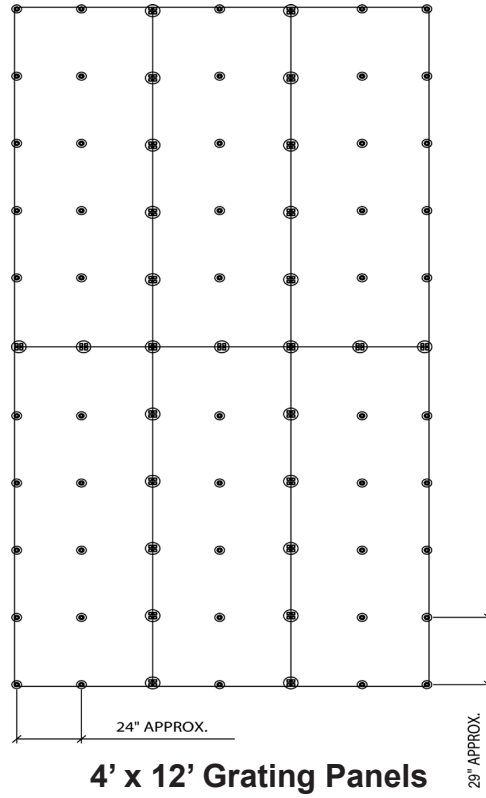
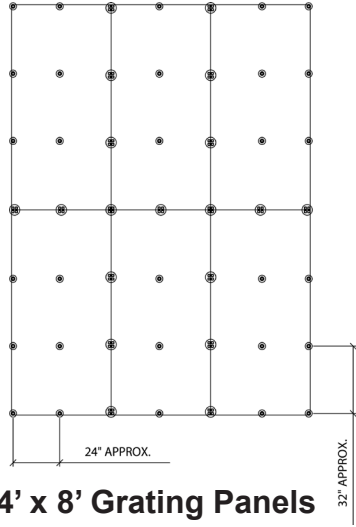
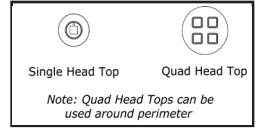

Pedestal Layouts

2" deep x 2" square mesh
100 psf
deflection $\leq 0.25"$

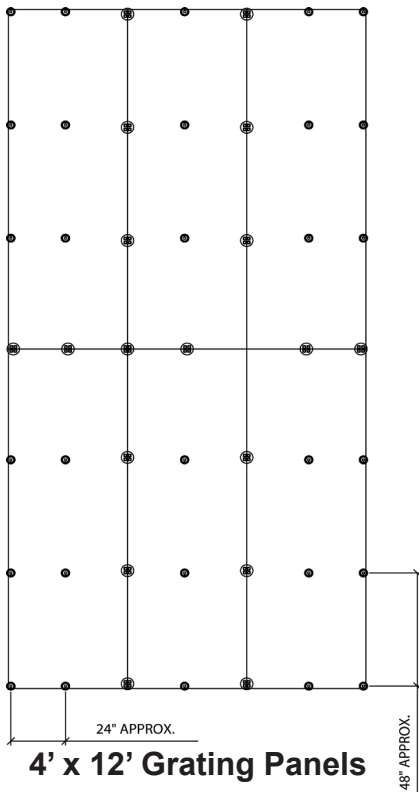

2" deep x 2" square mesh
200 psf
deflection $\leq 0.25"$

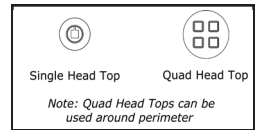
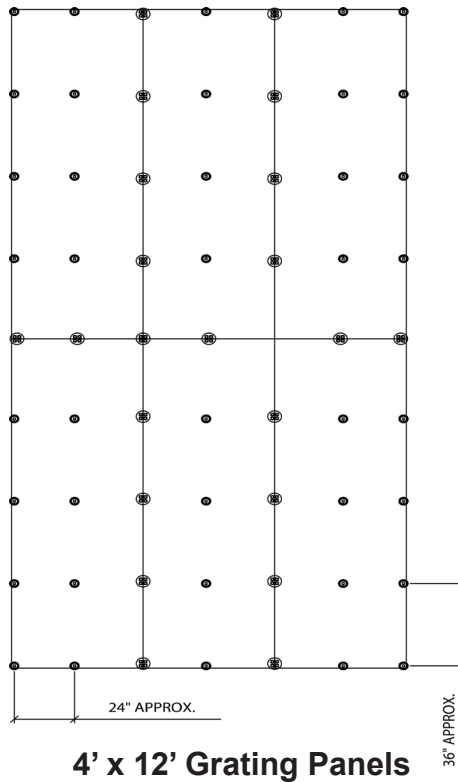

Installation Tips

Due to its versatility, there is a wide variety of applications for Fibergrate's grating pedestal system; therefore, installation will vary depending on the specific application. Thought and planning are the key ingredients to a smooth and trouble-free installation.

Step 1 Survey area to be covered with pedestal support system. Plan a starting and ending point. (Typically, areas are started in the corner containing the longest straight edge of the surface to be covered.)

Step 2 Assemble the leg components received according to height required to provide a level support system, and place adjacent to the first row of grating to be installed.

Step 3 Install pedestals according to the layouts and load specifications provided on pages 7 - 11 of this brochure.

Step 4 Adjust grating pedestals of first row of grating panels to create a level walking surface by

rotating the bases or the quad heads under the grating by hand and the single heads with a 1/2" drive socket from walking surface. **Take care not to adjust beyond the red maximum adjustment mark on the stainless steel adjustment rod.**

Step 5 Layout second grating panel row to be installed. Connect second row to first using the exposed portion of the quad heads. Continue installing row two according to **Steps 3 - 4.**

Step 6 Repeat steps 3 - 5 until installation is complete. Trimming of panels on last row is normally required for close fit.

Installation Notes:

1. Most contractors find the use of a laser level significantly speeds the leveling process during installation.
2. Fibergrate grating pedestal system is designed to provide structural support for walking surface; however, lateral support should be provided through attachment to adjacent equipment or containing the grating within perimeter walls of grating layout area.

For single head retainer clip instructions, see page 3.

Fibergrate Products & Services

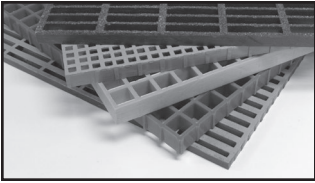

Fibergrate® Molded Grating

Fibergrate molded gratings are designed to provide the ultimate in reliable performance, even in the most demanding conditions. Fibergrate offers the widest selection in the market with multiple resins and more than twenty grating configurations available in many panel sizes and surfaces.



Safe-T-Span® Pultruded Industrial & Pedestrian Gratings

Combining corrosion resistance, long-life and low maintenance, Safe-T-Span® provides unidirectional strength for industrial and pedestrian pultruded grating applications.

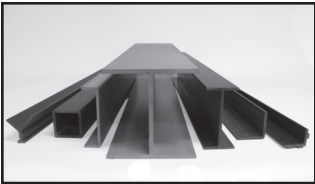

Dynaform® Structural Shapes

Fibergrate offers a wide range of standard Dynaform® pultruded structural profiles for industrial and commercial use, including I-beams, wide flange beams, round and square tubes, bars, rods, channels, leg angles and plate.



Dynarail® Guardrail, Handrail & Safety Ladder Systems

Easily assembled from durable components or engineered and prefabricated to your specifications, Dynarail® handrail and safety ladder systems meet or exceed OSHA and strict building code requirements for safety and design.

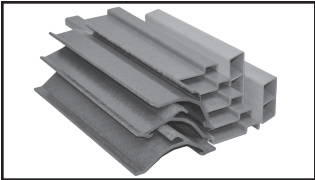

Custom Composite Solutions

Combining Fibergrate's design, manufacturing and fabrication services allows Fibergrate to offer custom composite solutions to meet our client's specific requirements. Either through unique pultruded profiles or custom open molding, Fibergrate can help bring your vision to reality.



Design & Fabrication Services

Combining engineering expertise with an understanding of fiberglass applications, Fibergrate provides turnkey design and fabrication of fiberglass structures, including platforms, catwalks, stairways, railings and equipment support structures.



Worldwide Sales & Distribution Network

Whether a customer requires a platform in a mine in South Africa to grating on an oil rig in the North Sea, or walkways in a Wisconsin cheese plant to railings at a water treatment facility in Brazil; Fibergrate has sales and service locations throughout the world to meet the needs and exceed the expectations of any customer.

Fibergrate Composite Structures Inc. believes the information contained here to be true and accurate. Fibergrate makes no warranty, expressed or implied, based on this literature and assumes no responsibility for the consequential or incidental damages in the use of these products and systems described, including any warranty of merchantability or fitness. Information contained here can be for evaluation only. The marks and trade names appearing herein, whether registered or unregistered, are the property of Fibergrate Composite Structures Inc.

©Fibergrate Inc. 2013 Part No. 885106-06/13-2.5
Printed in the USA

